

# BrickNerd Instructions



## Cassette Tape

*Design by the BrickNerd Team*

The cassette tape was a game-changer back in the day, making music portable and personal. To celebrate this retro classic, our design stays true to the real thing. It has curved corners, tape reels, a label, and even the little clear window that shows the tape inside.

Building this set is like hitting play on nostalgia. It'll take you back to the days of making mixtapes for your buddies and recording your favorite song from the radio. And it ever implements a sweet little stud inversion on the sides to keep things interesting.

So get your pencils out because it is time to be kind and rewind!

## Parts List

*(Parts can be ordered through [Bricklink.com](http://Bricklink.com) by searching by part number and color)*

Qty	Part	Color	Description
2	2431.dat	Black	Tile 1 x 4 with Groove
1	3004.dat	Trans Clear	Brick 1 x 2
10	3005.dat	Black	Brick 1 x 1
3	3023b.dat	Reddish Brown	Plate 1 x 2
2	3024.dat	Red Plate	1 x 1
2	3024.dat	Orange	Plate 1 x 1
2	3024.dat	Yellow	Plate 1 x 1
2	3024.dat	Green	Plate 1 x 1
2	3024.dat	Black	Plate 1 x 1
2	3024.dat	Blue	Plate 1 x 1
1	3069b.dat	Black	Tile 1 x 2 with Groove
2	3070b.dat	Black	Tile 1 x 1 with Groove
4	3460.dat	Black	Plate 1 x 8
6	4477.dat	White	Plate 1 x 10
4	6091.dat	Black	Brick 2 x 1 x 1.333 with Curved Top
2	6541.dat	Lt Bluish Grey	Technic Brick 1 x 1 with Hole
6	51739.dat	Black	Wing 2 x 4
4	52107.dat	Black	Brick 1 x 2 with Studs on Sides
4	86996.dat	Black	Plate 1 x 1 x 0.667
2	87994.dat	Lt Bluish Grey	Bar 3L

1

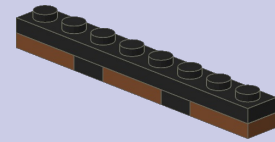
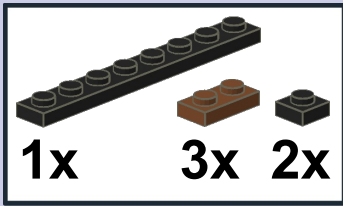

2

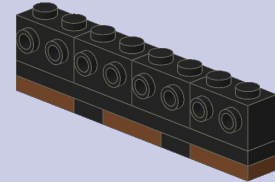

3

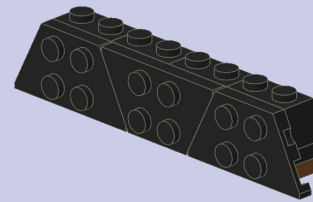

4

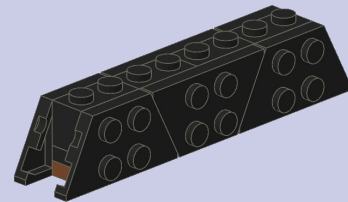

5

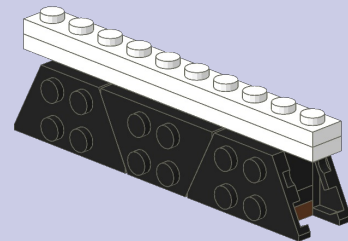
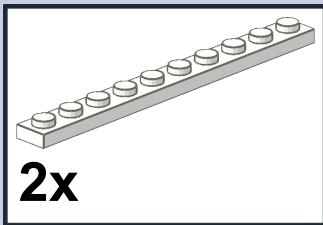

6

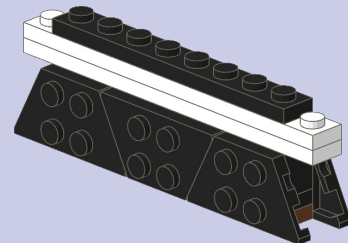
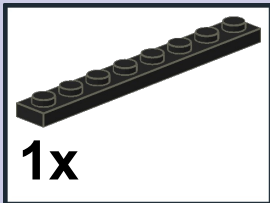

7

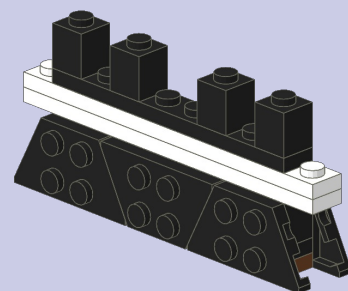

8

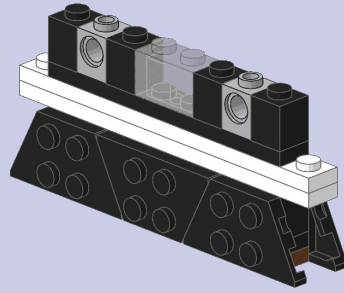

9

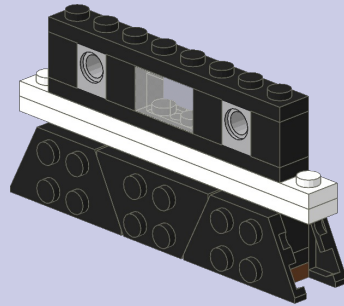
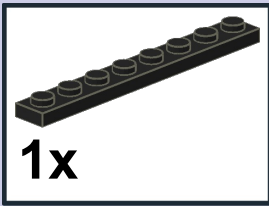

10

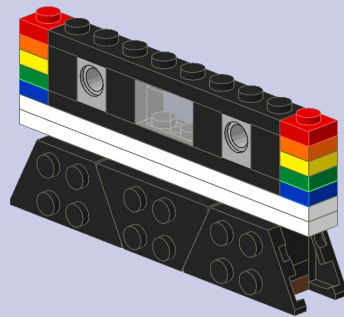
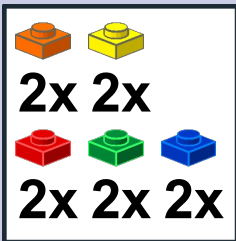

11

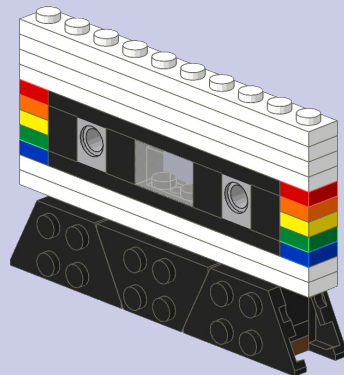
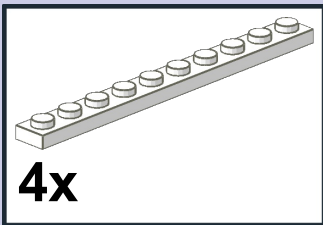

12

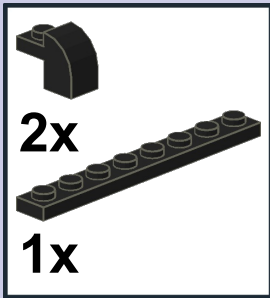

13

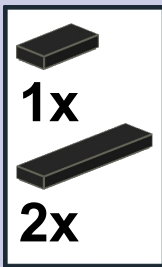

14



15

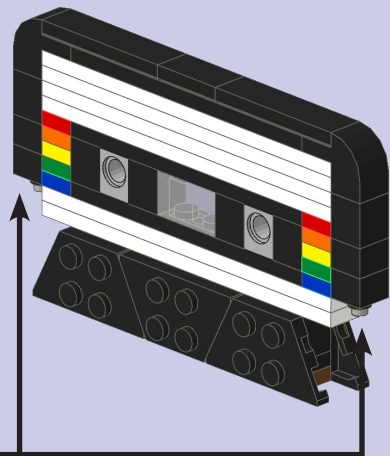
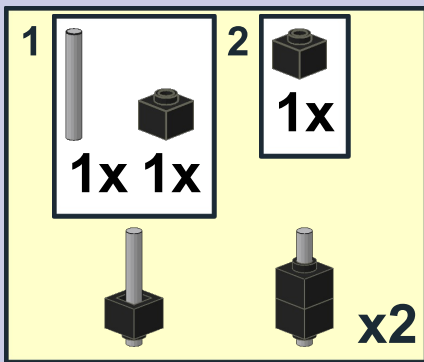

16

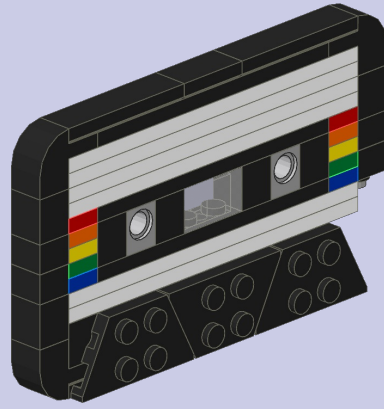
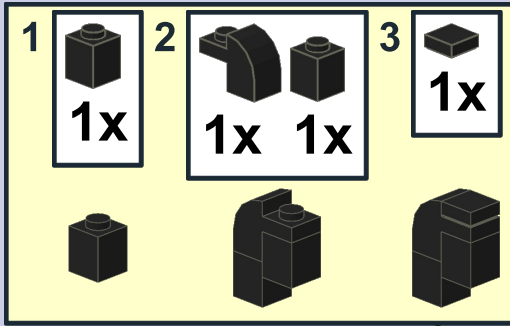

17

